

Gauge and Depth

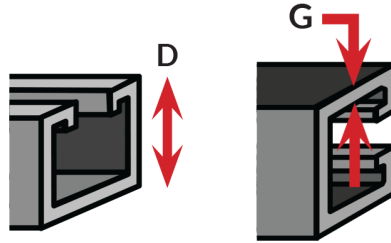

12 GAUGE 0.102
1-5/8" x 1-5/8" D

Length

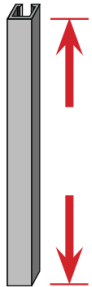





- **STANDARD 10'** (Shorter runs for easy handling)
- **STANDARD 20'** (Typical for longer runs)
- **6'8"** (Typical for commercial joists distance)
- **CUSTOM CUT-TO-LENGTH**



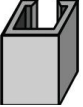



Perforation

	OVAL SLOT (Half slot) [9/16" x 11/8" x 2" on ctr.]
	LONG SLOT (Elongated slot) [13/32" x 3" x 4" on ctr.]
	ROUND HOLE [9/16" DIAM x 1-7/8" on ctr.]
	KNOCK OUT [7/8" DIAM x 6" on ctr.]
	CONTINUOUS CONCRETE INSERT
	SOLID (No perforation)

Material

	STEEL (Carbon steel, structural grade, 33,000 min yield)
	STAINLESS STEEL [304 or 316]
	ALUMINUM
	FIBERGLASS

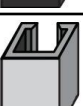
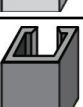
Finish

	PRE-GALVANIZED (Continuous galvanized) - G90 zinc coating weight for cost-effective long-term galvanic and barrier corrosion protection
	HOT DIPPED Galvanized (HDG – after fabrication, batch dip) where aqueous or exterior applications require greater corrosion protection
	GREEN Powder or “e”-coated painted topical coating
	PVC COAT Heavy PVC coat for extended barrier protection or cosmetic effects (May PVC coat over plain or galvanized)
	WIZCoat™ GALVANNEAL Paintable pregalvanized material requires no pre-treatment. Easily spray painted post-installation
	PLAIN Untreated, “plain” steel with no topical/barrier coating
	GOLD Yellow zinc dichromate electro-galvanized
	CUSTOM COLORS Custom powder coating available in virtually any color variations



Gregory G-STRUT Submittal Form

Project Name	
Project Start Date	
Architect or Engineer	
Phone	
Contractor(s)	
Address	
City	
State	
Zip	

Approval



G582 SERIES METAL FRAMING STRUT CHANNEL

1-5/8" x 1-5/8" (1.625" x 1.625") • 12 gauge (0.102" thick)

	G582OS [Oval-Slot] 9/16" x 1-1/8" - 2" ON CTR		G582A [Back-to-Back] WELDED
	G582LS [Long-Slot] 13/32" x 3" - 4" ON CTR		G582AOS [Back-to-Back Oval-Slot] WELDED
	G582H [Holes] 9/16" DIAM. - 1-7/8" ON CTR		G582KO [KNOCK OUT] 7/8" DIAM. - 6" ON CTR

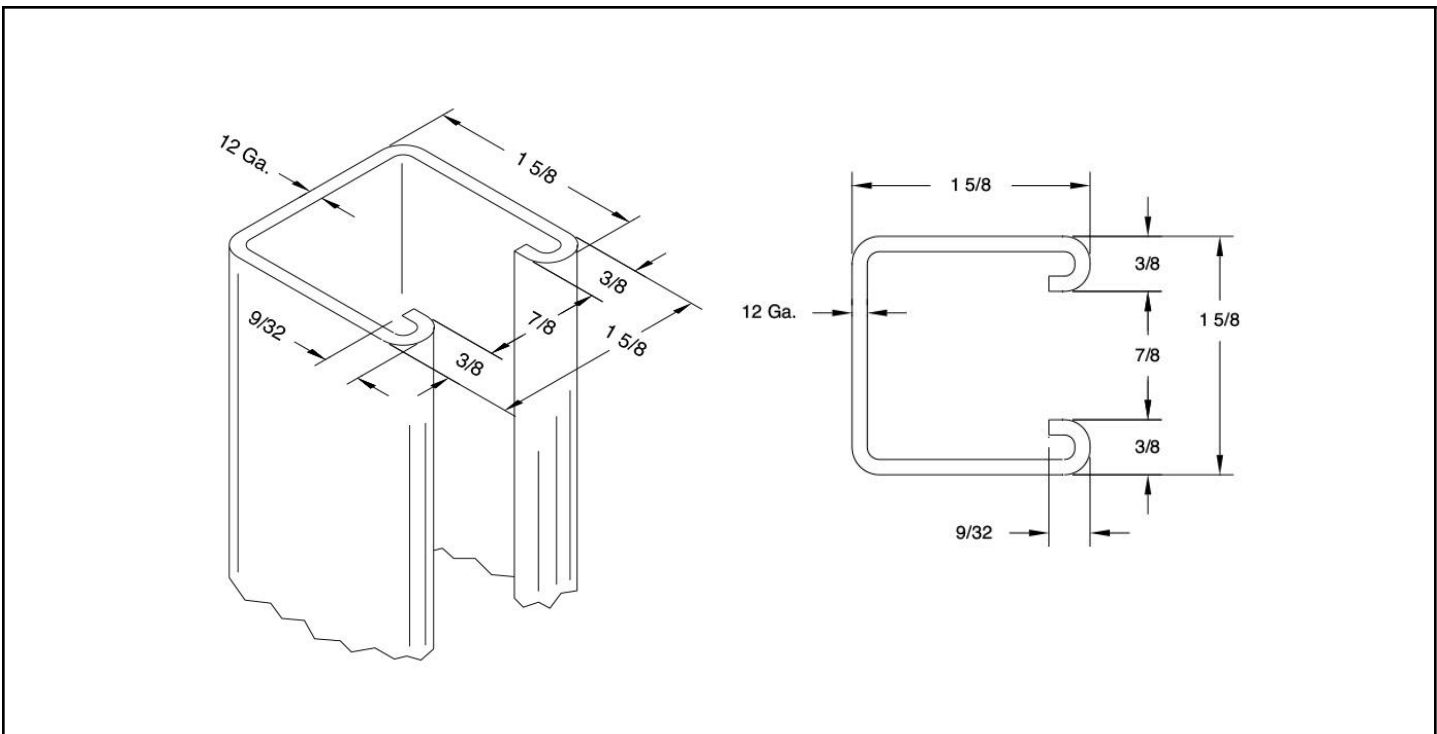

ITEM	QNT'Y	DESCRIPTION	MATERIAL
			ROLLFORM TOLERANCES
SCALE	FULL	CHK'D BY	LENGTH ± 0.125"
DWN BY	IDI	02-02-02	APP'D BY
ALL OTHER DIMENSIONS ± 0.020"			

G-STRUT CHANNEL, PART # G582

CAD FILENAME G582	GREGORY STRUT PRODUCTS Division of GRegory Industries 4100 13th Street SW, Canton, OH 44710 PH: 330-477-4800 • FX: 330-477-0626	REF. No.
LAST PLOT DATE 02-02-02		DRWG No. G582

This drawing is the property of Gregory Strut Prod. and is loaned without other consideration than the agreement and condition that it is not to be reproduced, copied or otherwise disposed of, directly or indirectly, and is not to be used in whole or in part to assist in making or to furnish any information for the making of drawings, prints apparatus or parts thereof. This drawing shall be returned to Gregory Strut Prod. upon request. The acceptance of this drawing will be construed as an acceptance of the foregoing conditions, and as an admission of the exclusive ownership in and to the drawing of Gregory Strut products.



G582 SERIES METAL FRAMING STRUT CHANNEL

ELEMENTS OF SECTION								
			X-X AXIS			Y-Y AXIS		
Strut Section No.	Weight/ Foot lbs.	Area of Section in. ²	Moment of Inertia in. ⁴	Section Modulus in. ³	Radius of Gyration in.	Moment of Inertia in. ⁴	Section Modulus in. ³	Radius of Gyration in.
G582	1.827	0.537	0.178	0.194	0.576	0.230	0.283	0.654
G582-A	3.655	1.074	0.891	0.548	0.911	0.460	0.566	0.654

BEAM & COLUMN LOADS					
Strut Section Number	Beam Span or Column Height	Maximum Column Load	Total Uniform Load @25,000 psi	Deflection @ 25,000 psi	Uniform Load @ 1/240 Span Deflection
	in.	lbs.	lbs.	in.	lbs.
G582	12	10960	3230	0.01	-
	18	10630	2150	0.03	-
	24	10250	1610	0.05	-
	30	9830	1290	0.08	-
	36	9370	1070	0.12	-
	42	8870	920	0.17	-
	48	8330	800	0.22	710
	54	7750	710	0.28	560
	60	7140	640	0.34	450
	66	6490	580	0.42	370
	72	5790	530	0.49	310
	84	4360	460	0.68	230
	96	3340	400	0.89	170
	108	2640	350	1.11	140
	120	2140	320	1.39	110
	132	1760	290	1.68	90
	144	-	260	1.95	70
	156	-	240	2.29	60
	168	-	230	2.75	50
	180	-	210	3.08	50
	192	-	200	3.57	30
	204	-	190	4.06	30
	216	-	170	4.32	30
	228	-	170	5.08	30
	240	-	160	5.57	20



G582 SERIES METAL FRAMING STRUT CHANNEL

BEAM & COLUMN LOADS					
Strut Section Number	Beam Span or Column Height	Maximum Column Load	Total Uniform Load @25,000 psi	Deflection @ 25,000 psi	Uniform Load @ 1/240 Span Deflection
	in.	lbs.	lbs.	in.	lbs.
G582A	12	22450	9130	0.00	-
	18	22150	6080	0.01	-
	24	21820	4560	0.03	-
	30	21460	3650	0.04	-
	36	21080	3040	0.07	-
	42	20660	2600	0.09	-
	48	20220	2280	0.12	-
	54	19760	2020	0.16	-
	60	19270	1820	0.19	-
	66	18400	1660	0.24	-
	72	17180	1520	0.28	-
	84	14530	1300	0.38	1170
	96	11630	1140	0.50	890
	108	9180	1010	0.64	700
	120	7440	910	0.79	570
	132	6150	830	0.96	470
	144	5160	760	1.14	390
	156	4400	700	1.33	330
	168	-	650	1.55	290
	180	-	600	1.76	250
	192	-	570	2.03	220
	204	-	530	2.26	190
	216	-	500	2.53	170
	228	-	480	2.86	150
240	-	450	3.13	140	

For Perforated Channels, Reduce Total Beam Load Values as Follows:

G582/G582A	OS	21%
G582/G582A	LS	34%
G582/G582A	H	13%
G582/G582A	KO	5%

E = 29000; Fy = 42700; K = 0.8



G582 SERIES METAL FRAMING STRUT CHANNEL

COLUMN LOADS: Column loads are for allowable axial loads for the unsupported heights listed (including a K value of 0.80). Column loads must be reduced for eccentric loading.

BEAM LOADS: Loads listed are distributed uniformly. For loads concentrated at center of span, multiply uniform load by 0.5 and deflection by 0.8. Where deflection is not a factor, use stress of 25,000 PSI. When deflection is a factor, use deflection of 1/240 span.