



4100 13th St. SW, Canton, OH 44710
866-997-8788 (866-99STRUT)

gregorystrut.com

G-STRUT is a product of Gregory Strut

200 SERIES

GRB216

ROOFTOP RISER SERIES WITH STRUT



Environmentally friendly blocks. Made from 100% recycled tires.

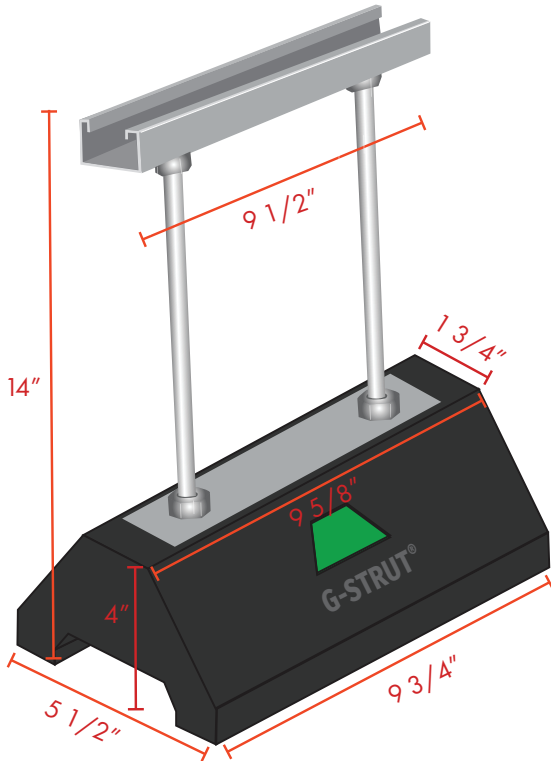

GRB216 FEATURES AND BENEFITS

Materials/finishes	100% recycled rubber base; 1 5/8" x 13/16" pre-galvanized strut (9 1/2")
Strut dimension	13/16" standard
Hardware	100% recycled rubber base; 1 5/8" x 13/16" pre-galvanized strut (9 1/2")
Safety	Green reflector for high visibility and safety
Weight (lbs.)	7.1
Height	Packing height: 12" Minimum height: 8" Maximum height: 14"
Static load capacity (lbs.)	500
Ordering	129 pieces per skid
Notes	Load distribution plate is available (2") Fender washers included

PROJECT INFORMATION

Project: _____

Address: _____

Contractor: _____

Engineer: _____

Date: _____

Approved

Approved as noted

Not approved

APPROVAL STAMP

Notes: _____



4100 13th St. SW, Canton, OH 44710
866-997-8788 (866-99STRUT)

gregorystrut.com

G-STRUT is a product of Gregory Strut

200 SERIES



Environmentally
friendly blocks.
Made from 100%
recycled tires.

200 SERIES OVERVIEW

- Comes pre-assembled at factory
- 14 gauge, 13/16" pre-galvanized steel channel
- Uses standard strut fittings and clamps
- 100% recycled rubber block
- UV resistant materials
- Green reflector for high visibility and safety
- Innovative design inhibits floating and shifting
- Freeze and thaw resistant
- LEED certifiable product
- Vibration dampening
- Compatible with most rooftop materials
(consult with roofing manufacturing or contractor)

GRB208



GRB212



GRB216





4100 13th St. SW, Canton, OH 44710
866-997-8788 (866-99STRUT)

gregorystrut.com

G-STRUT is a product of Gregory Strut

200 SERIES



Environmentally friendly blocks. Made from 100% recycled tires.

200 SERIES

PART #	DESCRIPTION
--------	-------------

GRB208	9.8" channel with 8" riser rod and LDP
---------------	--

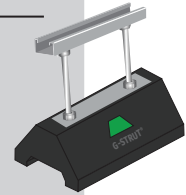

GRB212	9.8" channel with 12" riser rod and LDP
---------------	---

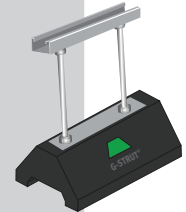

GRB216	9.8" channel with 16" riser rod and LDP
---------------	---

